

ЧИП-СВЕТОДИОД AR-3528-SAA

ОПИСАНИЕ И ПРИМЕНЕНИЕ

Чип-светодиоды AR-3528-SAA белого цвета свечения выполнены в корпусе SMD3528 (3.5 x 2.8 x 1.27 мм). Светодиоды имеют широкий спектр применений: осветительные приборы, декоративная подсветка архитектурных объектов, интерьерная подсветка.

ОСОБЕННОСТИ

- Индекс цветопередачи: 80+, 90+, 95+ (зависит от цветовой температуры)
- Цветовая температура: 2000-20000 К
- Номинальный рабочий ток: 20 мА
- Эффективность: до 150 лм/Вт
- Световой поток: до 8.3 лм
- Диаграмма направленности: 120°
- Не содержит свинца

РАЗМЕР

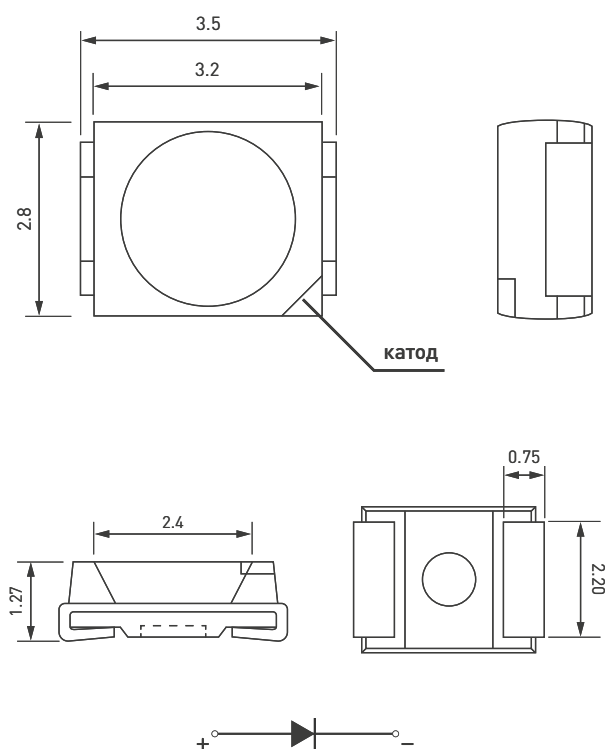

Все указанные размеры имеют допуск ± 0.1 мм.

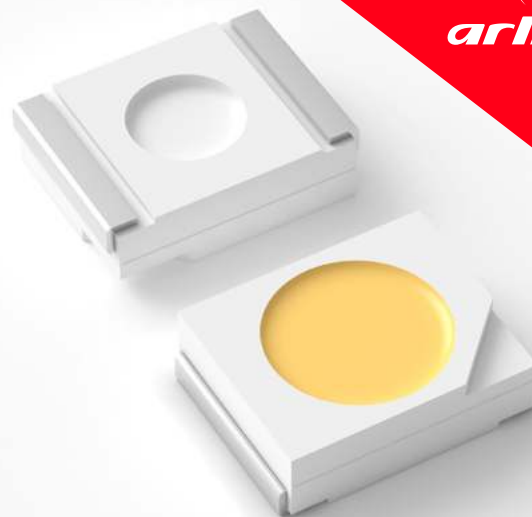

ПАРАМЕТРЫ

Артикулы **029053, 029054, 028118, 028117, 028116, 028115, 028114, 028924, 029099**

Модель **AR-3528-SAA**

ABSOLUTE MAXIMUM RATINGS ($T_s^*=25^\circ\text{C}$)

Parameter	Symbol	Value	Value
Power dissipation	P_D	100	mW
DC Forward Current	I_F	30	mA
Peak forward current**	I_{FP}	50	mA
Reverse Voltage	V_R	5	V
ESD Sensitivity	V_{ESD}	1000	V
Operating Temperature	T_{opr}	-40...85	°C
Storage Temperature	T_{stg}	-40...100	°C
Soldering Temperature	T_{sol}	260°C/8sec MAX	°C

* T_s – Solder point Temperature;
** Pulse width ≤ 0.1 msec.

TYPICAL CHARACTERISTICS ($T_s=25^\circ\text{C}$)

Parameter	Symb.	Note	Min.	Typ.	Max.	Unit
Forward Voltage (Divided into 6 groups)	V_F	IF=20mA	2.8	3.0	3.4	V
Luminous Flux	I_v	IF=20mA	6	*	8.3	lm
Reverse Current	I_R	VR=5V			1	μA
50% Power Angle	$2Q_{1/2}$	IF=20mA		120		Deg
Saturated Red	R_9	IF=20mA	0			-
Thermal resistance (junction to solder point)	R_{j-s}	-	130	135	150	K/W
Temperature coefficient of voltage	K_{vV}	IF=20mA	-2.33	-1.75	-1.35	mV/°C

ЭЛЕКТРООПТИЧЕСКИЕ ХАРАКТЕРИСТИКИ

($T_s=25^{\circ}\text{C}$, $I_F=20\text{mA}$)

CRI GROUPS

CRI80+ GROUP

CCT Group* (K)	I_F (mA)	CRI**			Luminous Flux, Lm		
		Min	Typ.	Max	Min	Typ.	Max
15000	20	83	85	88	6.4	6.7	7.5
8000	20	83	85	88	6.5	6.9	7.5
6000	20	83	86	88	7	7.4	8.1
5000	20	83	87	89	7	7.6	8.3
4000	20	83	86	89	7	7.5	8.2
3500	20	82	85	88	7	7.4	8.1
3000	20	81	83	87	7	7.3	8
2700	20	80	82	86	6.5	7.2	7.7
2400	20	78	80	84	6.45	7	7.5

CRI90+ GROUP

CCT Group* (K)	I_F (mA)	CRI**			Luminous Flux, Lm		
		Min	Typ.	Max	Min	Typ.	Max
6000	20	89	90	95	6.5	6.7	7.5
5000	20	90	91	95	6.5	6.7	7.5
4000	20	90	92	95	6.5	6.7	7.5
3500	20	90	92	95	6	6.5	7.5
3000	20	90	93	95	6	6.4	7
2700	20	90	92	95	6	6.4	7

CRI95+ GROUP

CCT Group* (K)	I_F (mA)	CRI**			Luminous Flux, Lm		
		Min	Typ.	Max	Min	Typ.	Max
6000	20	95	96	98	5.5	6	6.5
5000	20	95	96	98	5.7	6	6.5
4000	20	95	96	98	5.7	6	6.5
3500	20	95	96	98	5.5	5.9	6.3
3000	20	95	96	98	5.5	5.8	6.2
2700	20	95	96	98	5.4	5.6	6

* - LEDs with another color temperature can be manufactured on special order.

** - LEDs can be made with the following CRI: 80+; 85+; 90+; 95+; 98+ (but from the range between the minimum and maximum values).

ГРУППИРОВКА ПО СВЕТОВЫМ ХАРАКТЕРИСТИКАМ

White BINs

CCT Group	BIN code	x	y
2400K	23D	0.4979	0.4235
		0.5035	0.4258
		0.5061	0.4193
		0.5005	0.4171
	23C	0.4923	0.4213
		0.4979	0.4235
		0.5005	0.4171
		0.4949	0.4148
	23B	0.4868	0.419
		0.4923	0.4213
		0.4949	0.4148
		0.4894	0.4126

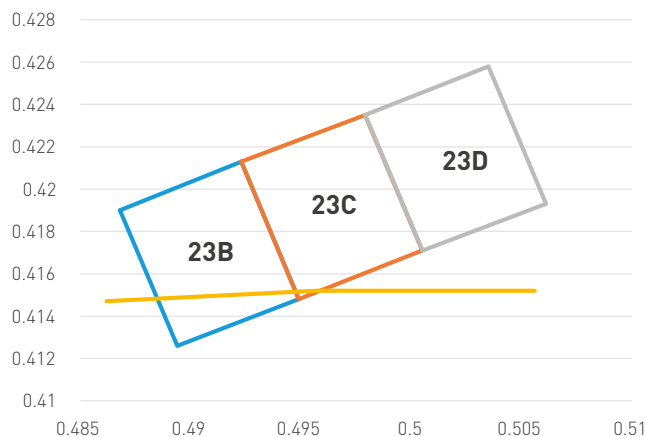

Figure 1 – 2400K BINs Coordinates

White BINs

CCT Group	BIN code	x	y
2700K	27J	0.4586	0.4063
		0.4632	0.4101
		0.4676	0.4046
		0.463	0.4008
	27L	0.4632	0.4101
		0.4679	0.4139
		0.4723	0.4085
		0.4676	0.4046
	27N	0.4679	0.4139
		0.4726	0.4177
		0.477	0.4123
		0.4723	0.4085

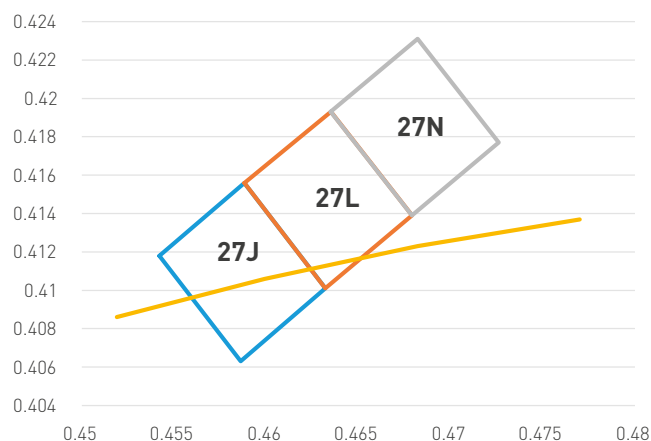

Figure 2 – 2700K BINs Coordinates

White BINs

CCT Group	BIN code	x	y
3000K	30G	0.4305	0.4052
		0.4349	0.4092
		0.4396	0.404
		0.4351	0.4
	30H	0.4349	0.4092
		0.4394	0.4132
		0.4441	0.408
		0.4396	0.404
	30J	0.4394	0.4132
		0.4438	0.4173
		0.4485	0.4121
		0.4441	0.408

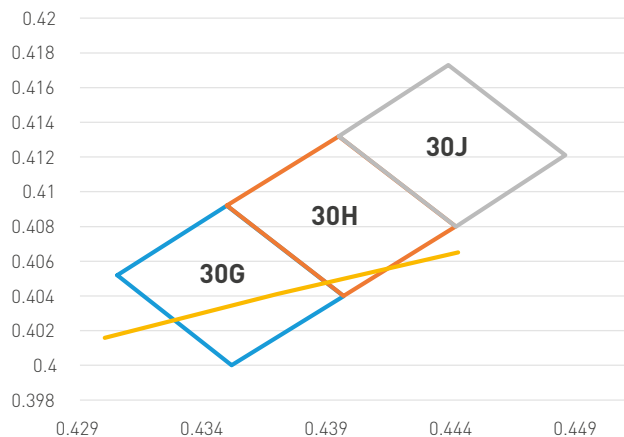

Figure 3 – 3000K BINs Coordinates

White BINs			
CCT Group	BIN code	x	y
3500K	35B	0.4001	0.3914
		0.4042	0.3958
		0.4093	0.391
		0.4052	0.3866
	35C	0.4042	0.3958
		0.4083	0.4002
		0.4134	0.3954
		0.4093	0.391
	35D	0.4083	0.4002
		0.4124	0.4046
		0.4175	0.3998
		0.4134	0.3954

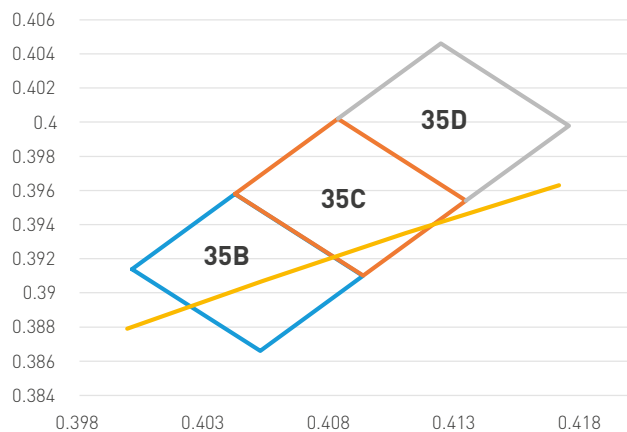

Figure 4 – 3500K BINs Coordinates

White BINs			
CCT Group	BIN code	x	y
4000K	39E	0.3729	0.3694
		0.377	0.3738
		0.3828	0.3683
		0.3787	0.3639
	39F	0.377	0.3738
		0.3811	0.3782
		0.3869	0.3727
		0.3828	0.3683
	39G	0.3811	0.3782
		0.3852	0.3826
		0.391	0.3771
		0.3869	0.3727

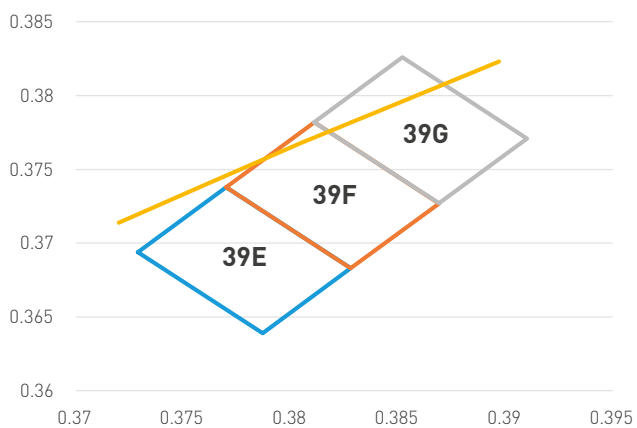

Figure 5 – 4000K BINs Coordinates

White BINs			
CCT Group	BIN code	x	y
5000K	51B	0.3376	0.3508
		0.3414	0.3554
		0.3468	0.351
		0.343	0.3464
	50C	0.3414	0.3554
		0.3451	0.3601
		0.3506	0.3557
		0.3468	0.351
	49D	0.3451	0.3601
		0.3489	0.3648
		0.3543	0.3603
		0.3506	0.3557

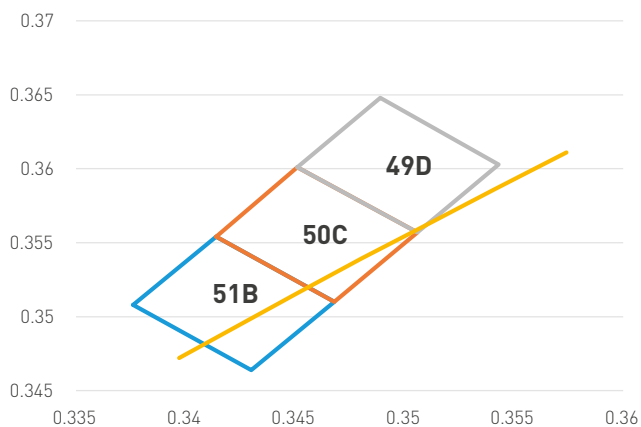

Figure 5 – 5000K BINs Coordinates

White BINs

CCT Group	BIN code	x	y
6000K	62C	0.3135	0.3212
		0.3168	0.3261
		0.3234	0.3217
		0.3201	0.3167
	60D	0.3168	0.3261
		0.3202	0.3311
		0.3268	0.3266
		0.3234	0.3217
	58E	0.3202	0.3311
		0.3235	0.3361
		0.3302	0.3316
		0.3268	0.3266

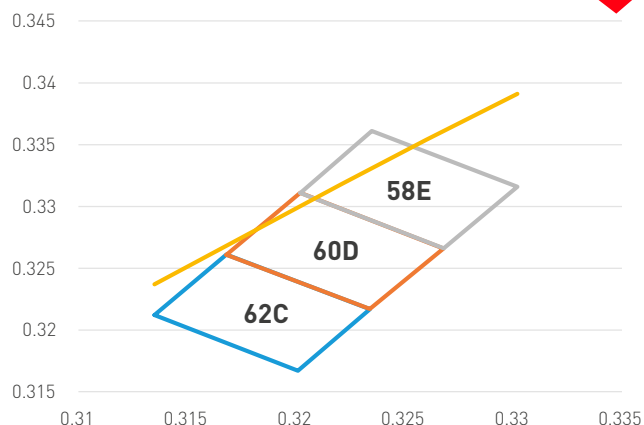

Figure 6 – 6000K BINs Coordinates

White BINs

CCT Group	BIN code	x	y
8000K	80-3	0.2814	0.2901
		0.2844	0.2961
		0.2904	0.2961
		0.2874	0.2901
	80-4	0.2844	0.2961
		0.2875	0.3021
		0.2935	0.3021
		0.2904	0.2961
	75-3	0.2875	0.3021
		0.2906	0.3081
		0.2966	0.3081
		0.2935	0.3021

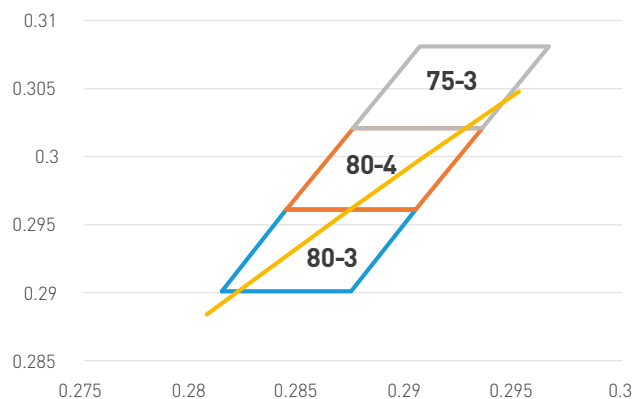

Figure 7 – 8000K BINs Coordinates

White BINs

CCT Group	BIN code	x	y
15000K	170-A6	0.2624	0.261
		0.2649	0.266
		0.2689	0.2585
		0.2664	0.2535
	200-A5	0.2599	0.256
		0.2624	0.261
		0.2664	0.2535
		0.2639	0.2485
	230-A4	0.2574	0.251
		0.2599	0.256
		0.2639	0.2485
		0.2614	0.2435
	270-A3	0.2549	0.246
		0.2574	0.251
		0.2614	0.2435
		0.2589	0.2385

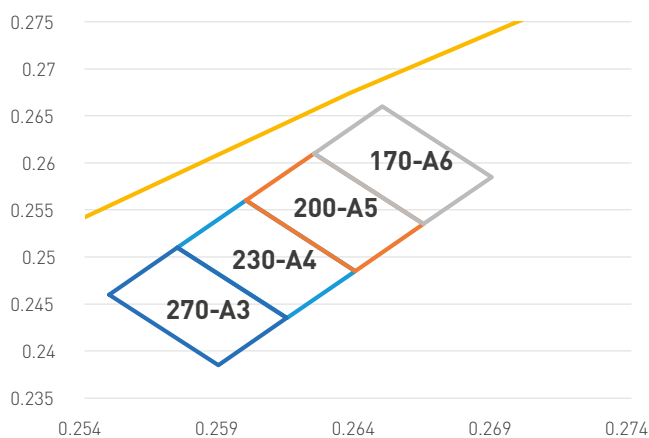
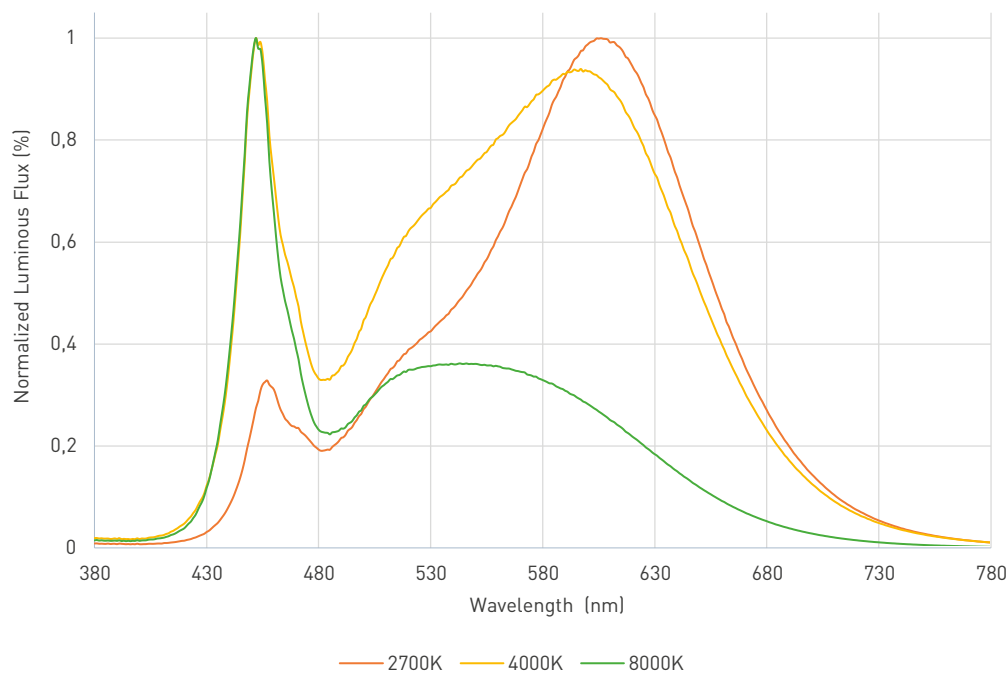

Figure 8 – 15000K BINs Coordinates

Note: Tolerance of measurement of chromatic coordinates: ± 0.005

ТИПОВЫЕ ЗАВИСИМОСТИ ЭЛЕКТРООПТИЧЕСКИХ ХАРАКТЕРИСТИК

LUMINOUS FLUX VS. WAVELENGTH



RELATIVE LUMINOUS INTENSITY VS. ANGLE

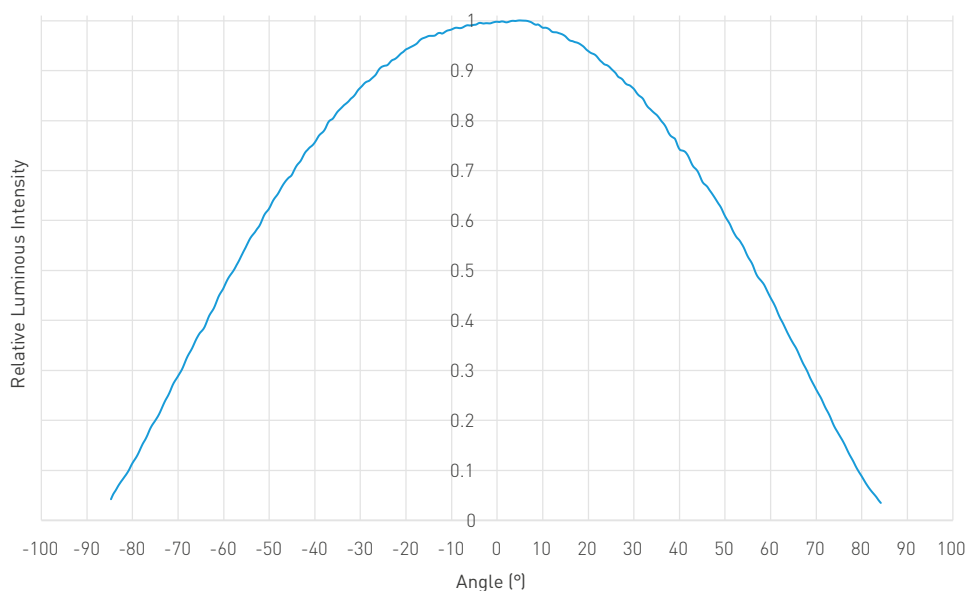

RELATIVE LUMINOUS INTENSITY VS. T_s

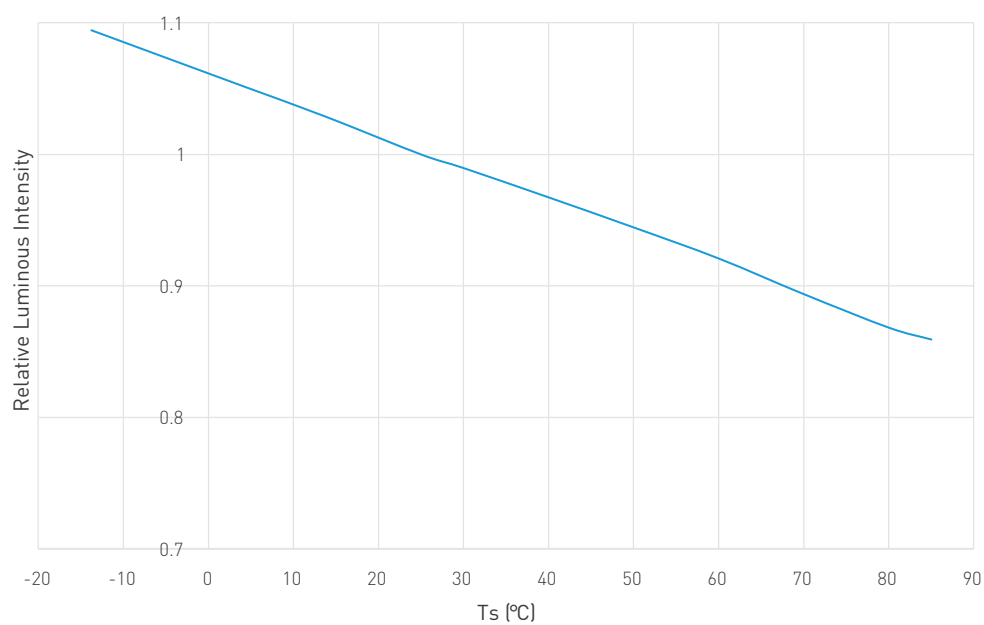

RELATIVE CHROMATICITY VS. TEMPERATURE (2700K)

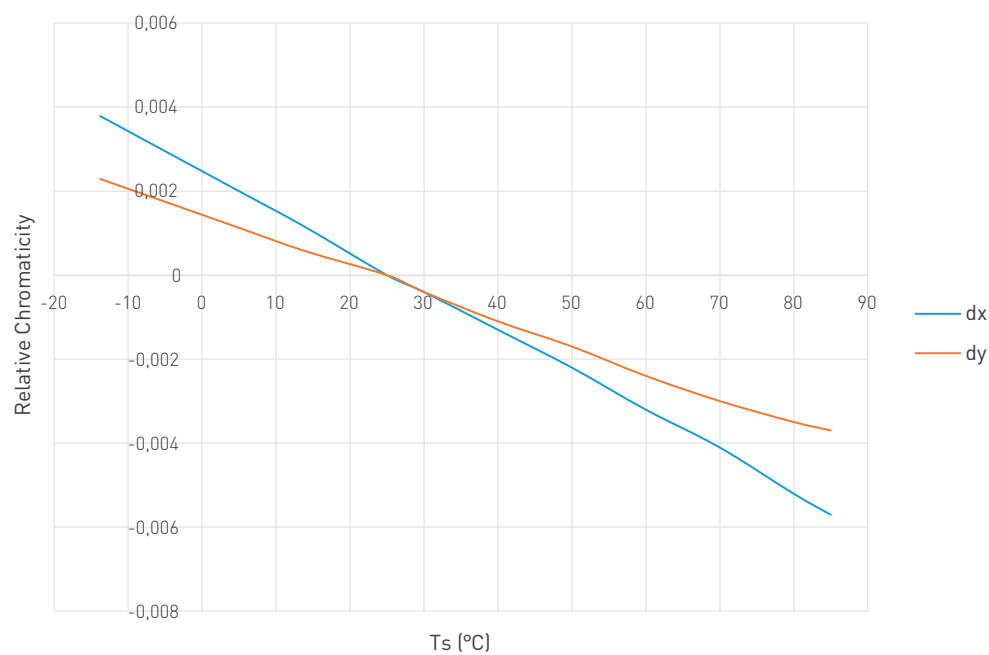

RELATIVE CHROMATICITY VS. FORWARD CURRENT

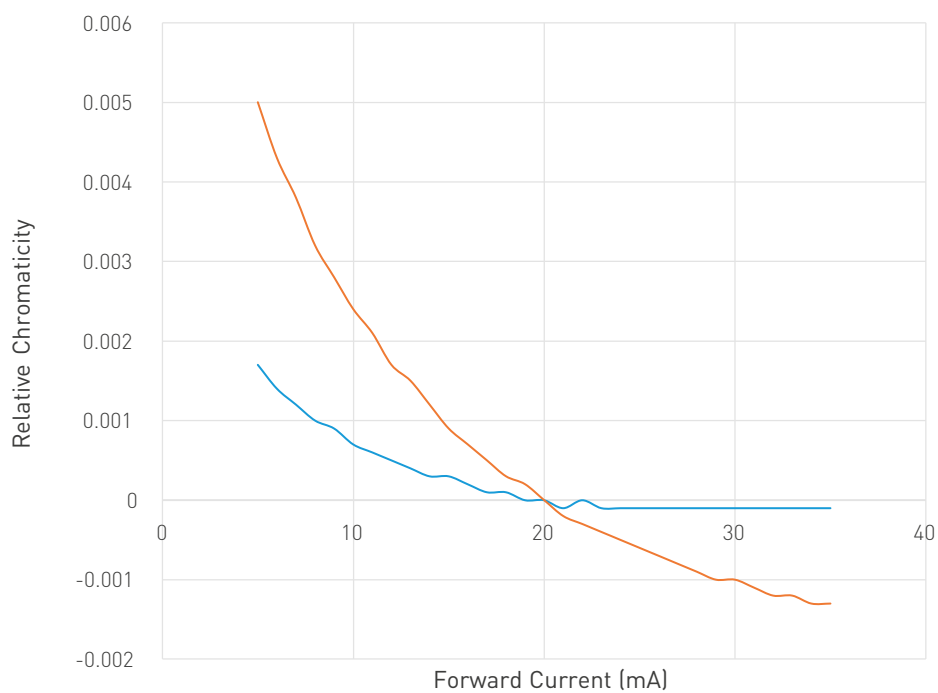

RELATIVE LUMINOUS INTENSITY VS. FORWARD CURRENT

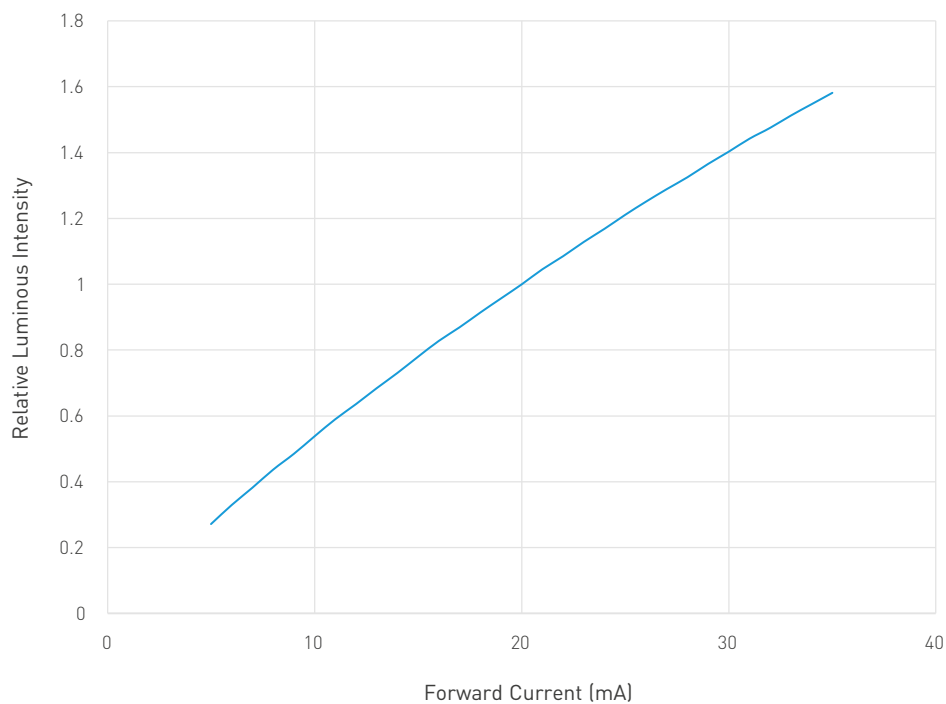

ELECTRICAL CHARACTERISTICS (TYPICAL)

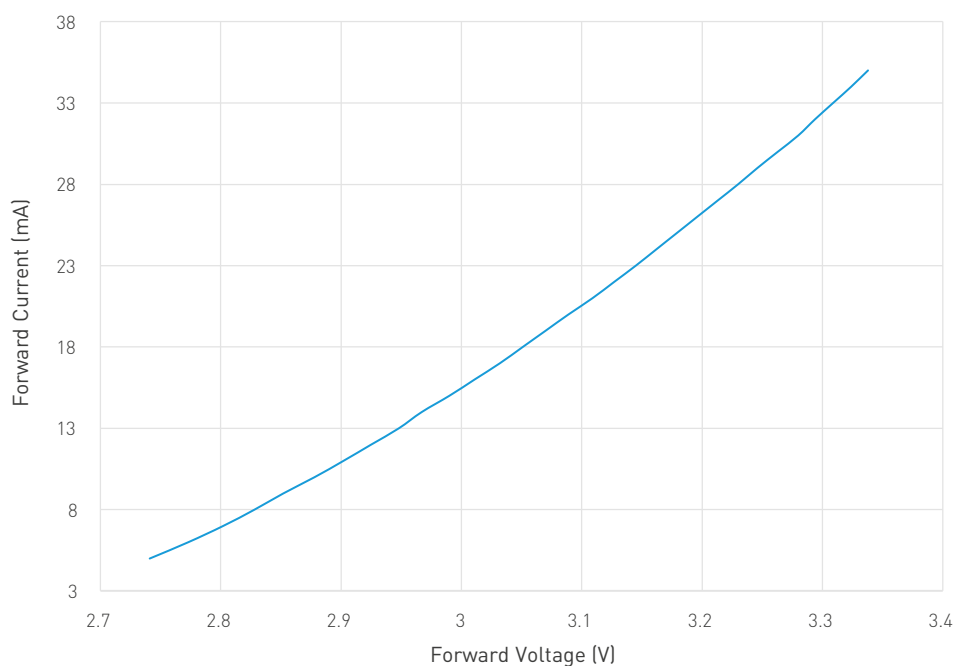

VOLTAGE BIN STRUCTURE

Group	Min Voltage (V)	Max Voltage (V)
VF:2.8-2.9	2.8	2.9
VF:2.9-3.0	2.9	3.0
VF:3.0-3.1	3.0	3.1
VF:3.1-3.2	3.1	3.2
VF:3.2-3.3	3.2	3.3
VF:3.3-3.4	3.3	3.4

Note: Forward voltage measurement allowance is $\pm 0.03V$.

MAXIMUM FORWARD CURRENT DERATING CURVE VS. AMBIENT TEMPERATURE

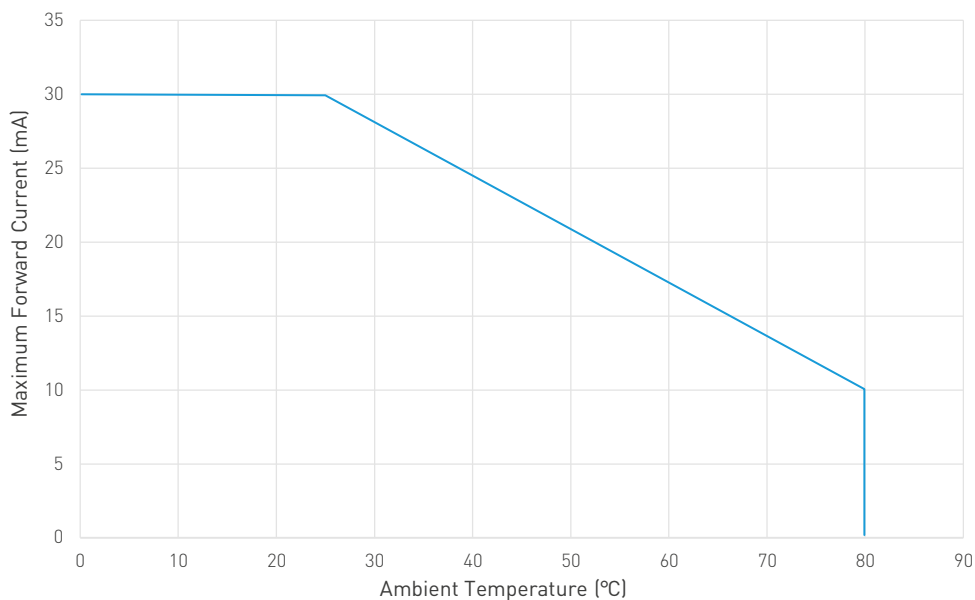

ОБОЗНАЧЕНИЕ ЧИПА СВЕТОДИОДОВ ARLIGHT

AR-3528-SAA-White6000-85 (3V, 20mA)

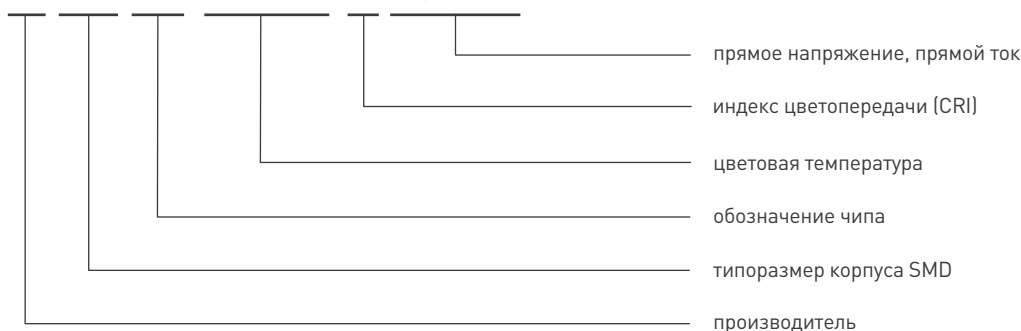

Артикул	Наименование
029053	Светодиод AR-3528-SAA-Warm2400-85 (3V, 20mA) (ARL, SMD 3528 (PLCC2))
028115	Светодиод AR-3528-SAA-Warm2700-85 (3V, 20mA) (ARL, SMD 3528 (PLCC2))
028114	Светодиод AR-3528-SAA-Warm3000-85 (3V, 20mA) (ARL, SMD 3528 (PLCC2))
029054	Светодиод AR-3528-SAA-Warm3500-85 (3V, 20mA) (ARL, SMD 3528 (PLCC2))
028116	Светодиод AR-3528-SAA-Day4000-85 (3V, 20mA) (ARL, SMD 3528 (PLCC2))
028117	Светодиод AR-3528-SAA-White5000-85 (3V, 20mA) (ARL, SMD 3528 (PLCC2))
028118	Светодиод AR-3528-SAA-White6000-85 (3V, 20mA) (ARL, SMD 3528 (PLCC2))
028924	Светодиод AR-3528-SAA-Cool8000-85 (3V, 20mA) (ARL, SMD 3528 (PLCC2))
029099	Светодиод AR-3528-SAA-Cool15000-85 (3V, 20mA) (ARL, SMD 3528 (PLCC2))

Примечание: по требованию заказчика возможно изготовление светодиодов с другим значением цветовой температуры. Желаемая цветовая температура должна находиться в диапазоне, указанном на стр. 2. Значение CRI должно быть выбрано из диапазона, указанного на стр. 2 для ближайшего значения цветовой температуры.

РЕКОМЕНДУЕМЫЙ ПРОФИЛЬ ПАЙКИ

LEAD SOLDER

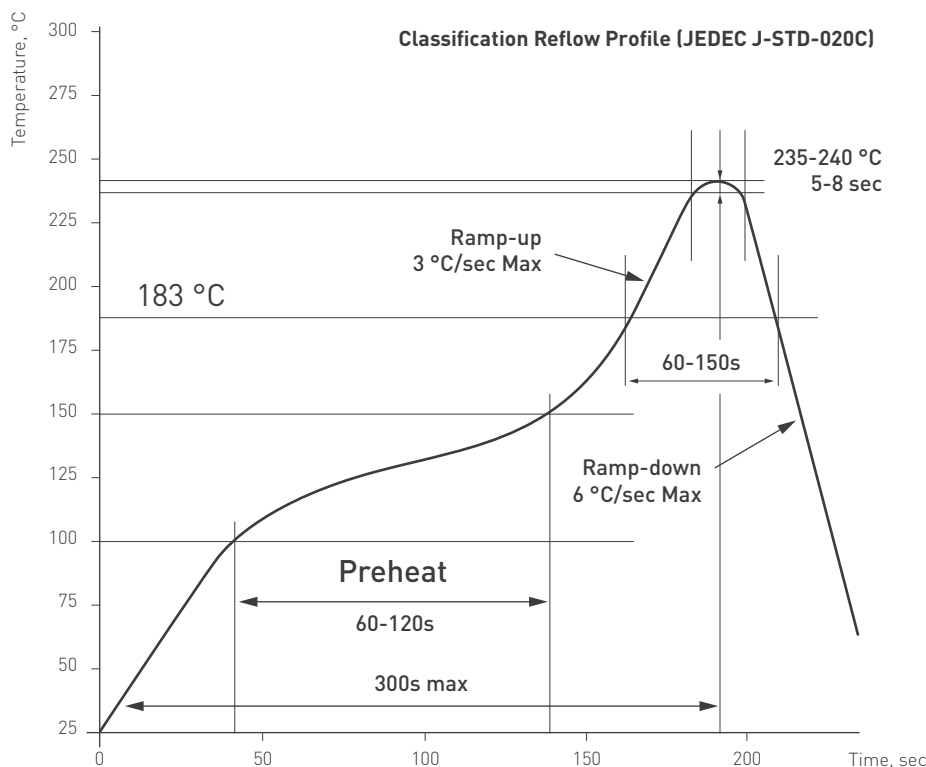

Recommended soldering pad

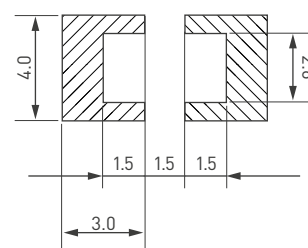

LEAD-FREE SOLDER

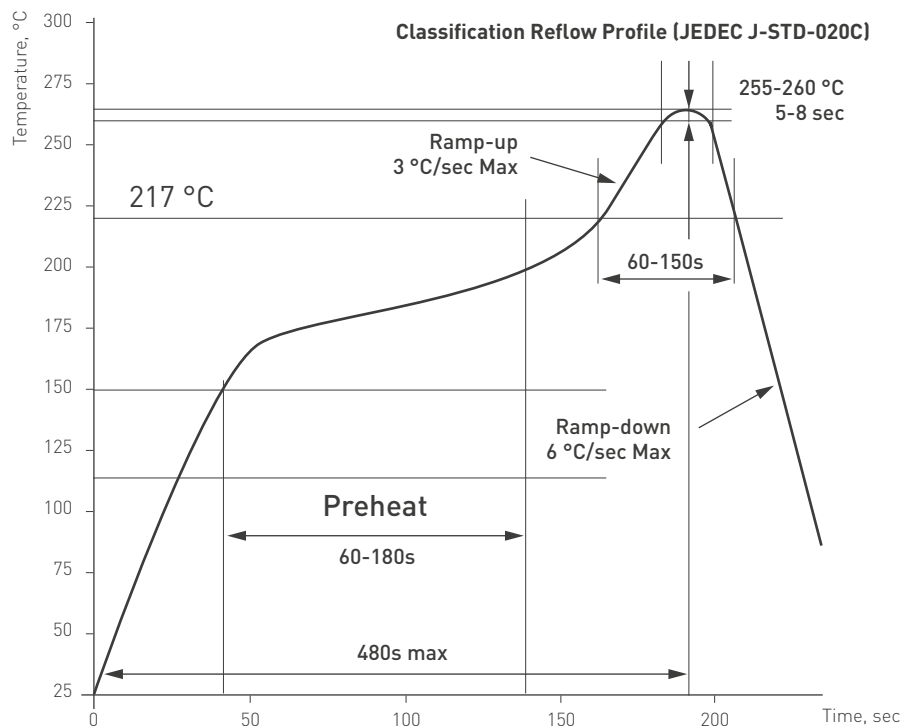

УПАКОВКА

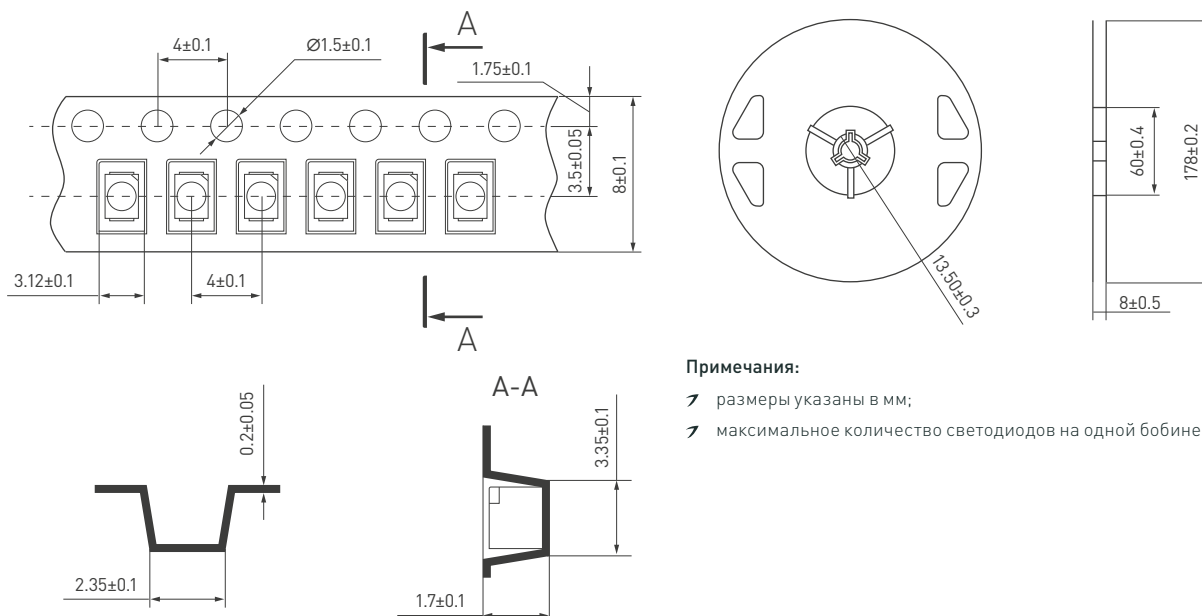

Примечания:

- размеры указаны в мм;
- максимальное количество светодиодов на одной бобине — 3000 шт.

МАРКИРОВКА

ЭТИКЕТКИ НА БОБИНУ

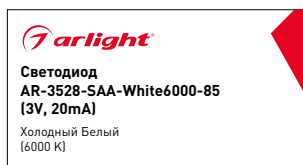

ЭТИКЕТКА НА ПАКЕТ

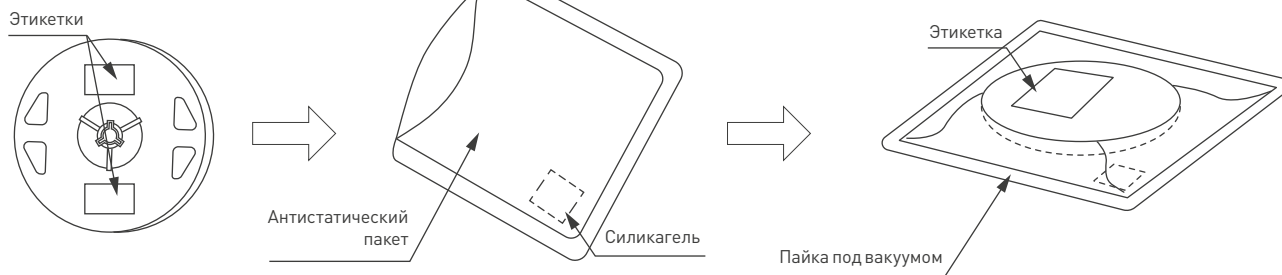

ТРАНСПОРТНЫЙ КОРОБ

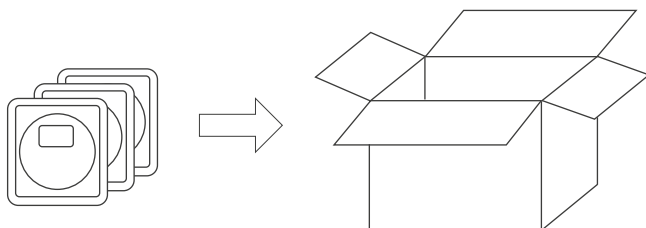

ИСПЫТАНИЯ НА НАДЕЖНОСТЬ

ТЕСТЫ И РЕЗУЛЬТАТЫ

Type of Test	Criterion	Test conditions	Duration	Samples	Suited (%)
Running	Turning on	TA=25°C±5°C *IF=20mA	1000 hours	20	100%
Env. test	High temperature	TA=100°C±5°C	1000 hours	20	100%
	Low temperature	TA=-40°C±5°C	1000 hours	20	100%
	Temperature and humidity	TA=60°C±5°C RH=85%±5%	1000 hours	20	100%
	Thermal shock	10°C±5°C(15min)<>100°C±5°C (15min)	100 cycles	20	100%
	Thermal cycling	-40°C-25°C-100°C-25°C 30min-5min-30min-5min	300 cycles	20	100%
Mechanical test	Resistance to soldering temperature	255-260°C, 8 sec	Once	20	100%

Note:

The test for resistance to soldering temperature is carried out first.

КРИТЕРИИ ДЛЯ ОЦЕНКИ ГОДНОСТИ

Characteristic	Symbol	Conditions	Evaluation criterion	
			Min	Max
Supply voltage	V_F	IF=20 mA	---	Basic x 1.02
Luminous intensity	I_v	IF=20 mA	Basic x 0.7	---

ВНИМАНИЕ!

1. Не превышайте номинальную мощность.
2. Избегайте воздействия статического электричества (ESD).
3. Не допускайте механического воздействия (давления посторонних предметов) на люминофор.
4. Срок хранения в оригинальной упаковке при температуре $<40^{\circ}\text{C}$ и относительной влажности $<95\%$ составляет 12 месяцев с даты производства.
5. После вскрытия упаковки, рекомендуется использовать светодиоды в течение 72 часов.
6. При хранении светодиодов в открытой упаковке более 72 часов перед использованием выполните сушку при температуре 65°C в течение не менее 24 часов.
7. Избегайте хранения в условиях конденсации влаги (ниже точки росы).