

МОЩНЫЙ СВЕТОДИОД ARPL-12W-LTA-1414-97

ОСОБЕННОСТИ

- Высокая световая эффективность (>100 лм/Вт)
- Высокий индекс цветопередачи (CRI>97)



ПРИМЕНЕНИЕ

- Светодиодные светильники (трековые, даунлайты)

ГАБАРИТНЫЕ РАЗМЕРЫ

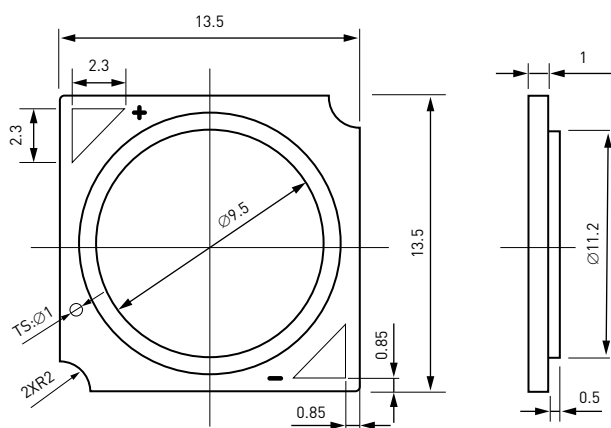

Notes: All dimensions are in millimeters (mm), tolerances are ± 0.3 mm.

LIMIT PARAMETERS

Parameter	Symbol	Min	Max	Unit
Forward Current	I_F	/	920	mA
Forward Voltage	V_F	33.6	39.6	V
Operating Temperature	T_{opr}	-10	+85	°C
Storage Temperature	T_{stg}	-40	+100	°C
Soldering Temperature	T_{sol}	/	350	°C
Junction Temperature	T_j	/	125	°C
Thermal Resistance	R_{j-c}	/	0.99	°C/W
Antistatic Ability	ESD	2000	/	V

The using temperature is less than 85°C; please reduce the using current or contact with us if using temperature is more than 85°C. When hand soldering, keep the temperature of iron below less 350°C less than 5 seconds.

ELECTRO-OPTICAL CHARACTERISTICS

($I_f = 600$ mA, $T_c = 25$ °C)

CCT	CRI, min Ra	R9	Luminous Flux Min	Typ	Efficacy (typ), lm/W	Voltage (typ), V
4000 K	97	90	2585	2700	121	37.2
3000 K	97	90	2075	2185	98	37.2

The tolerance of measurement at our tester is voltage $\pm 5\%$, luminous flux $\pm 7\%$ and $R_a/R_9 \pm 1$. Luminous flux inside the integrating sphere measurements.

Art.	CRI	I_f	flux
034744	97	360 mA	1390 lm
034741	97	360 mA	1390 lm

CHROMATICITY COORDINATE GROUPS

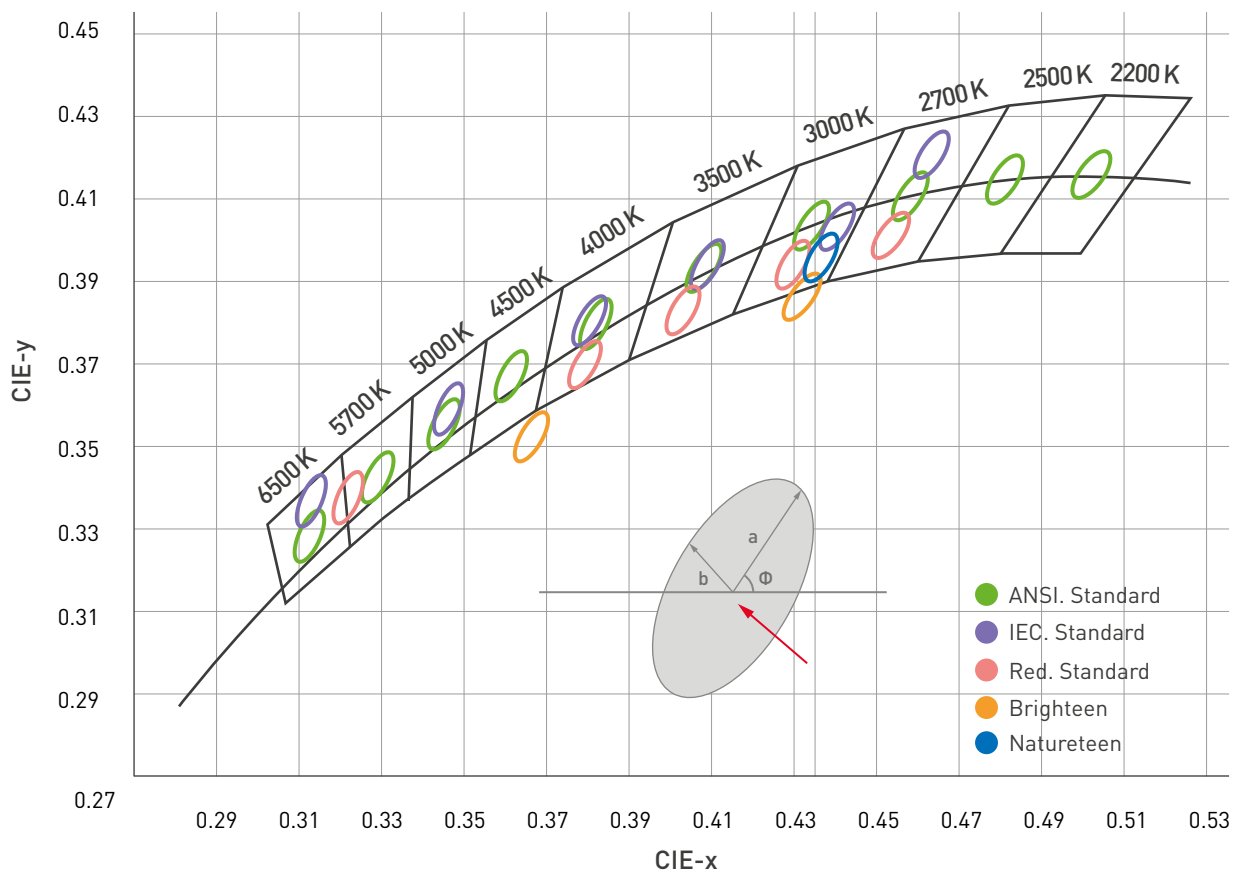

CHARACTERISTIC CURVES

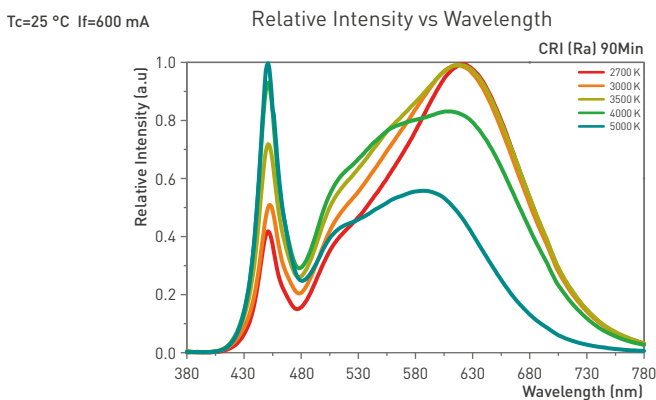
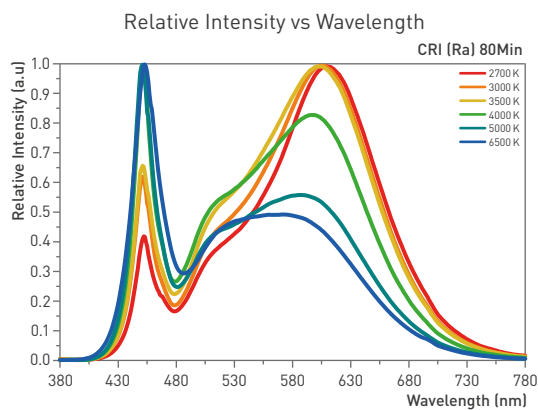
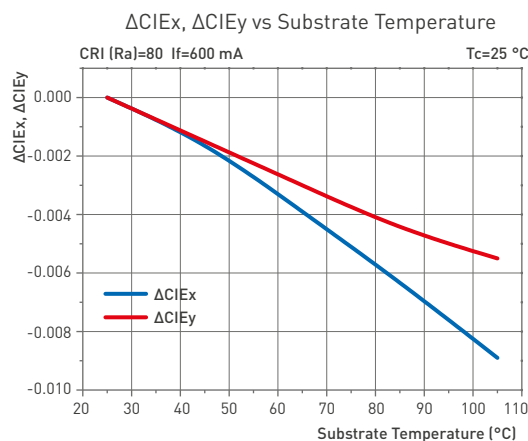
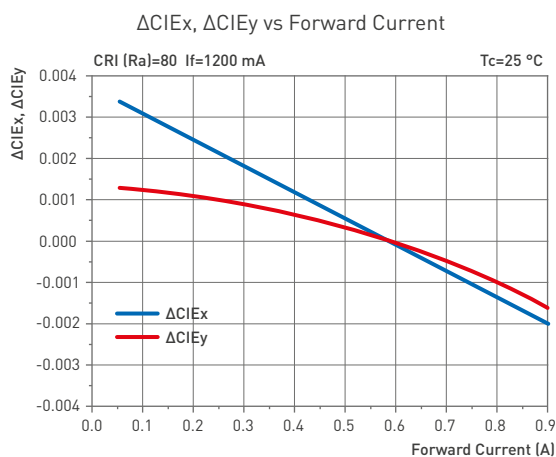
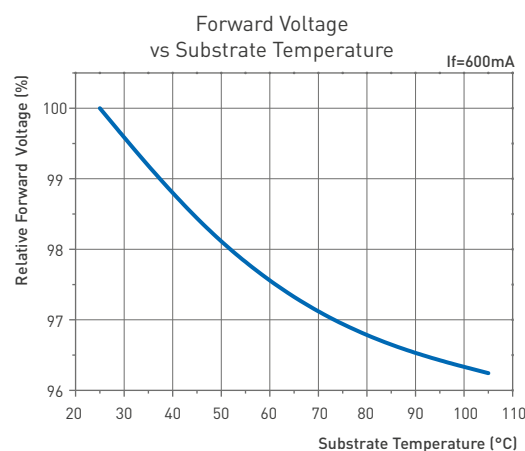
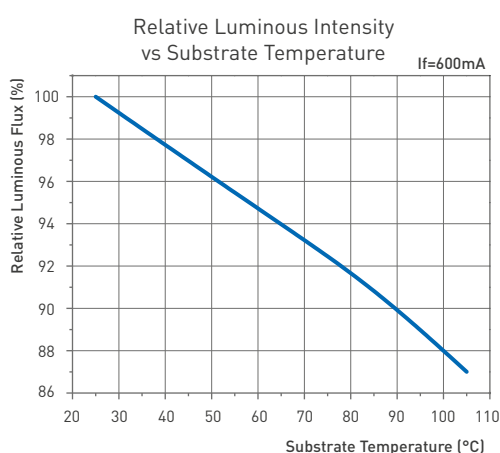
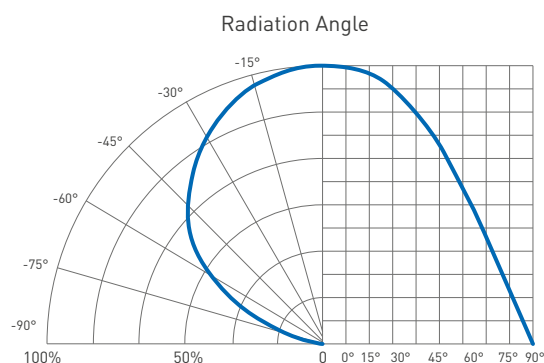
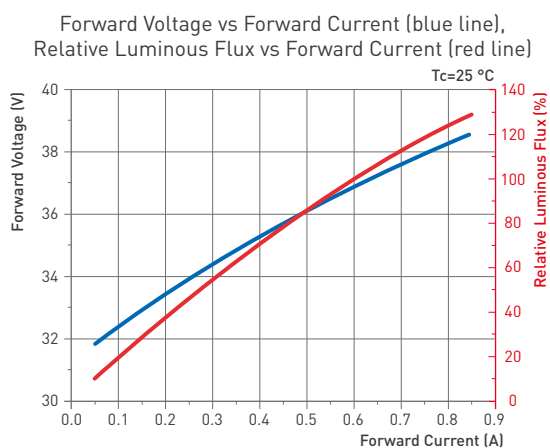

УПАКОВКА

