

МОЩНЫЙ СВЕТОДИОД ARPL-18W-TFA-1919-90

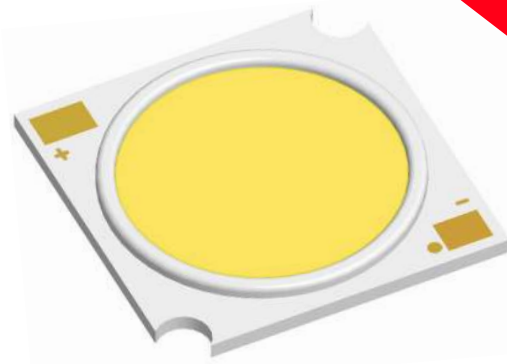

FEATURES

- Efficacy of 155 lm/W typical for 3000K, 80CRI.
- Compact high flux density light source.
- Uniform, high quality illumination.
- Minimum 70, 80, and 90 CRI options.
- StreaCLined thermal path.
- ENERGY STAR® / ANSI compliant color binning structure with 2, 3 and 5 SDCM standard.
- More energy efficient than incandescent, halogen and fluorescent lamps.
- High voltage or low voltage DC operation.
- Product series and company logo on the front.
- RoHS compliant.

BENEFITS

- Enhanced optical control.
- High quality, true color reproduction.
- Significantly reduced thermal resistance and increased operating temperature.
- Uniform, consistent white light.
- Lower operating cost.
- Easy to use with daylight and motion detectors to enable increased energy saving.
- Reduced maintenance cost.
- Environmentally friendly, no disposal issue.

MECHANICAL DIMENSION

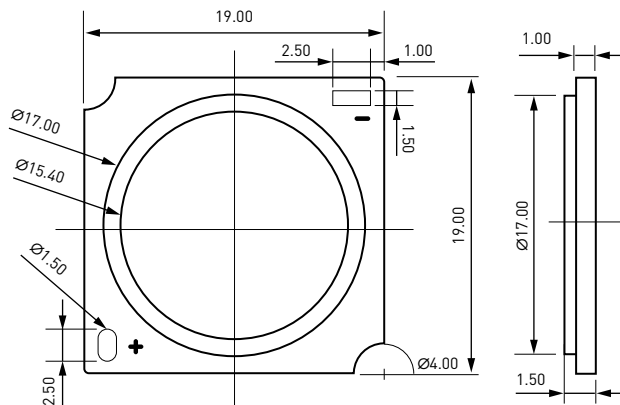

- Notes:
1. All dimension tolerance is $\pm 0.2\text{mm}$ unless otherwise noted.
 2. Tc measurement point at cathode pad of product.

ELECTRO-OPTICAL CHARACTERISTICS AT $T_j = 85^\circ\text{C}$

Part Number	Typical Power (W)	Nominal CCT (K)	CRI	Pulsed Flux (lm)		Typical Voltage (V)	Nominal Current (mA)	Typical Efficacy (lm/W)
				min	typ			
ARPL-18W-TFA-1919-Warm3000-90		3000		2225	2392			130
ARPL-18W-TFA-1919-Day4000-90	18.4	4000	90	2310	2484	34	540	135
ARPL-18W-TFA-1919-White5700-90		5700		2344	2520			137

1. Nominal CCT as defined by ANSI C78.377-2015.
2. Products tested based on operation under DC [Direct current] with LED array mounted onto a heat sink with thermal interface material and T_j (junction temperature) = 85°C .
3. Typical performance values are provided as a reference only and are not a guarantee of performance.
4. $\pm 7\%$ tolerance on flux measurements. $\pm 3\%$ tolerance on voltage measurements. ± 2 RA tolerance of Ra measurements.
5. Alternate drive currents are provided for reference only and are not a guarantee of performance.
6. $\Phi 25^\circ\text{C} = \Phi 85^\circ\text{C} / 0.895$.

ELECTRICAL CHARACTERISTICS

Part Number	Drive Current (mA)	Forward Voltage Pulsed, $T_j = 85^\circ\text{C}$ (V)			Typical Coefficient Of Forward Voltage $\Delta V_f / \Delta T_j$ (mV/ $^\circ\text{C}$)	Typical Thermal Resistance Junction to Case Rj-c ($^\circ\text{C}/\text{W}$)
		min	typ	max		
ARPL-18W-TFA-1919-90	540	33.6	34	40.8	-16	0.64

1. Products tested based on operation under DC [Direct current] with LED array mounted onto a heat sink with thermal interface material and T_j (junction temperature) = 85°C .
2. Voltage minimum and maximum are provided for reference only and are not a guarantee of performance.
3. A tester tolerance of $\pm 0.10\text{V}$ on forward voltage measurements.
4. Typical coefficient of forward voltage tolerance is $\pm 0.1\text{mV}$ for nominal current.
5. Thermal resistance values are based from test data of a 3000K 80 CRI product.
6. Thermal resistance value was calculated using total electrical input power; optical power was not subtracted from input power. The thermal interface material used during testing is not included in the thermal resistance value.
7. Vf min hot and max cold values are provided as reference only and are not guaranteed by test. These values are provided to aid in driver design and selection over the operating range of the product.

ABSOLUTE MAXIMUM RATINGS

Parameter	Maximum Rating
LED Junction Temperature (Tj)	125
Storage Temperature	-35...+120
Operating Temperature	-30...+105
Soldering Temperature	350 $^\circ\text{C}$/3-5S
Electrostatic Discharge (HBM)	2000V

1. Driven the arrays at higher currents, however lumen maintenance may be reduced.
2. Proper current derating must be observed to maintain junction temperature below the maximum.
3. Pulsed operation with a peak drive current equal to the stated peak pulsed forward current is acceptable if the pulse time is $\leq 1\text{ms}$ per cycle and the duty cycle is $\leq 10\%$.
4. Light emitting diodes are not designed to be driven in reverse voltage and will not produce light under this condition. Maximum rating provided for reference only.

PRODUCT NOMENCLATURE

ARPL-18W-TFA-1919-Day4000-90

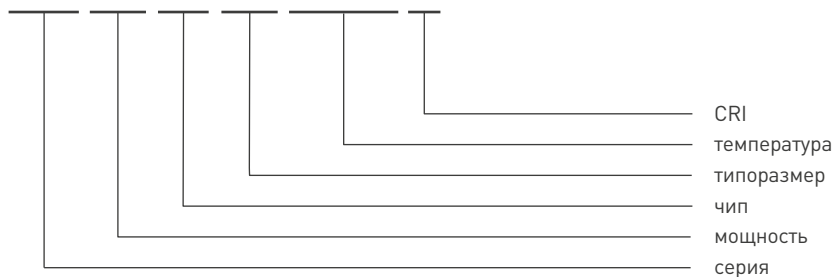

Артикул	Наименование	Примечание
036072	Мощный светодиод ARPL-18W-TFA-1919-Warm3000-90	Мощный светодиод типа COB, размер 19×19 мм. Цвет свечения теплый (3000 K). Угол излучения 120°. Световой поток 2225-2392 лм при If=540 мА, P=18.4 Вт. VF=34 В. CRI>90.
036074	Мощный светодиод ARPL-18W-TFA-1919-Day4000-90	Мощный светодиод типа COB, размер 19×19 мм. Цвет свечения дневной (4000 K). Угол излучения 120°. Световой поток 2310-2484 лм при If=540 мА, P=18.4 Вт. VF=34 В. CRI>90.
036075	Мощный светодиод ARPL-18W-TFA-1919-White5700-90	Мощный светодиод типа COB, размер 19×19 мм. Цвет свечения белый (5700 K). Угол излучения 120°. Световой поток 2344-2520 лм при If=540 мА, P=18.4 Вт. VF=34 В. CRI>90.

CHROMATICITY COORDINATE GROUPS

Graph of Test Bins in xy Color Space (Pulsed Test Conditions, $T_C=25^\circ\text{C}$)

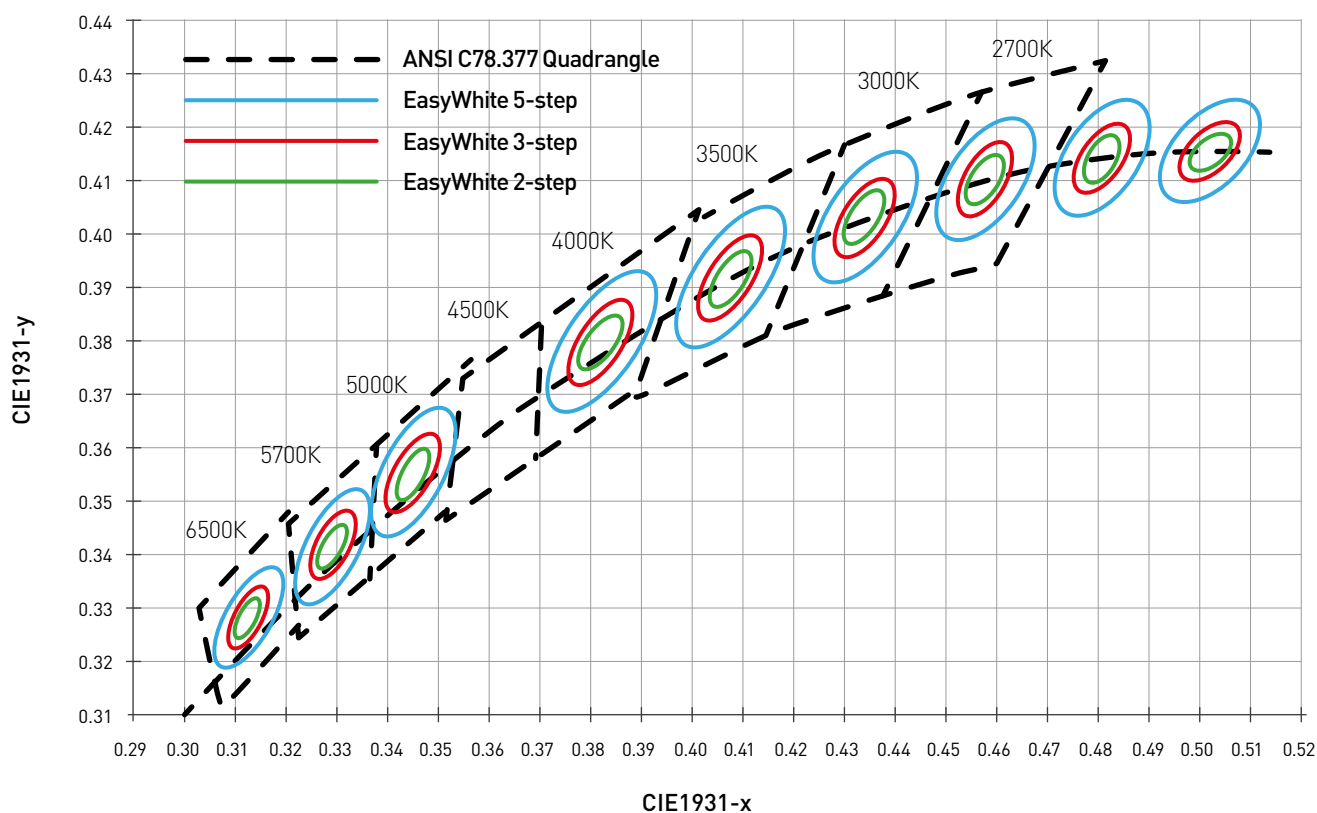

Nominal CCT	Center Point		MAJOR AXIS (a , b)			Ellipse Rotation Angel, θ
	X	Y	2-Step	3-Step	5-Step	
3000 K	0.4338	0.4030	(0.0057, 0.0028)	(0.0086, 0.0042)	(0.0142, 0.0069)	53.7
4000 K	0.3818	0.3797	(0.0063, 0.0027)	(0.0093, 0.0042)	(0.0157, 0.0068)	53.4
5700 K	0.3290	0.3417	(0.0048, 0.0021)	(0.0072, 0.0032)	(0.0119, 0.0052)	58.8

TYF maintains a tolerance of ± 0.005 on x and y coordinates in the CIE 1931 color space.

CHARACTERISTIC CURVES

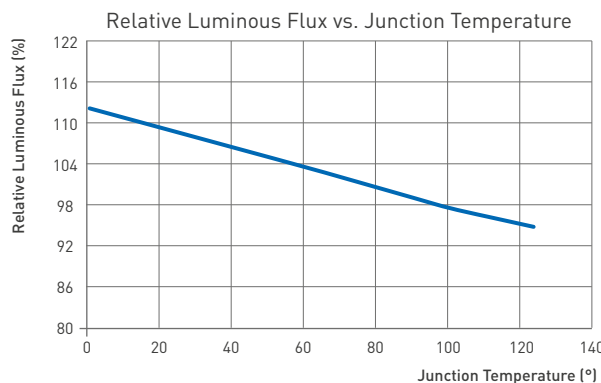
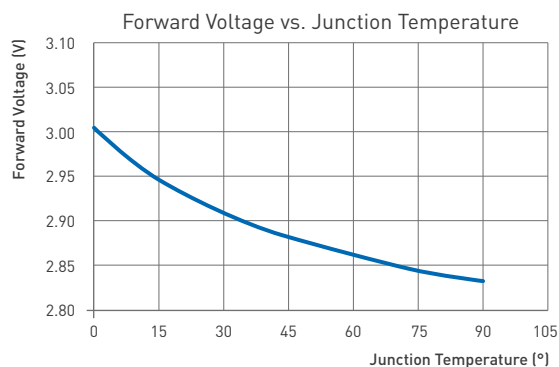
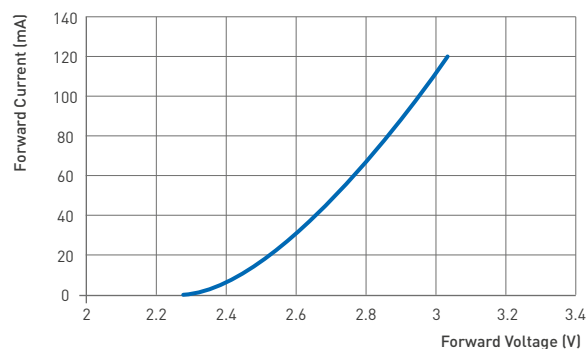
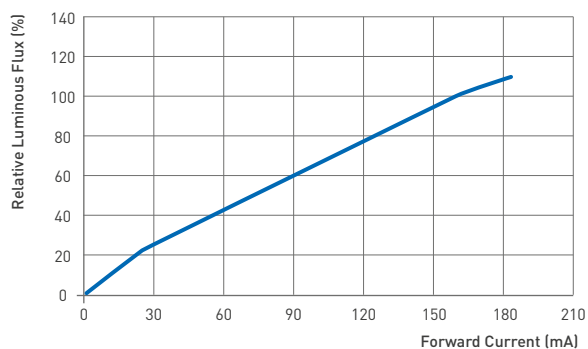

1. Figures for single LED chip.
2. TYF does not recommend driving our LED arrays at low currents. Doing so may produce unpredictable results.
3. Products tested based on operation under DC (Direct current) with LED array mounted onto a heat sink with thermal interface material and T_j (junction temperature) = 85 °C. Base on TYF test setup, values also depending on the thermal design and exposed environment to which the luminaire is subjected.

OPTICAL CURVES

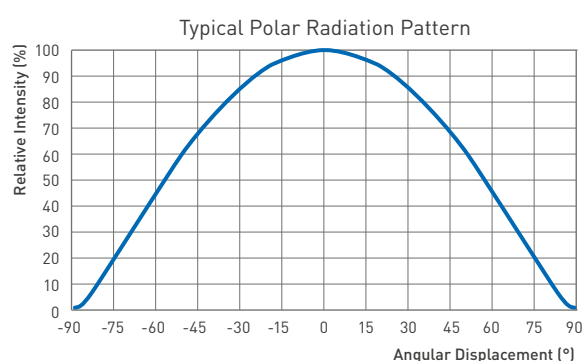
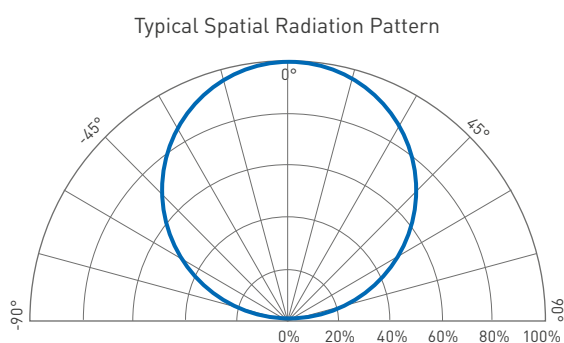

Typical viewing angle is 120°. The viewing angle is defined as the off axis angle from the center line where intensity is 1/2 of the peak value.

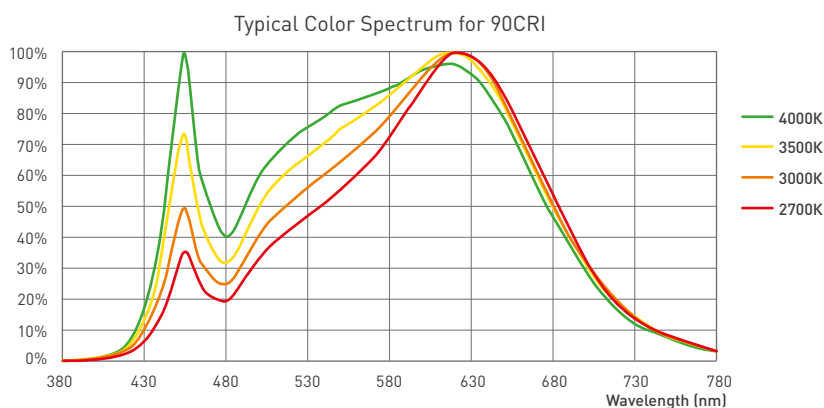

1. Color spectra measured at nominal current for $T_j = 25^\circ\text{C}$.
2. Color spectra shown is 2700K, 3000K, 3500K, 4000K and 90 CRI.

RELIABILITY TEST

Test Item	REF. Standard	Test condition	Sample count	Failure quantity
Thermal Shock	JESD22-A106	-40 °C (15min) ~ 100 °C (15min), 200 cycles	22	0
High Temperature Storage	JESD22-A103	Ta=120 °C, 1000h	22	0
Low Temperature Storage	JESD22-A119	Ta=-40 °C, 1000h	22	0
High Temperature High Humidity Life Test	JESD22-A101	Ta=85 °C, RH>=85%, 1000h	22	0
High Temperature Life Test	JESD22-A108	Ta=105 °C, IF=90mA@1 serie 1000h	22	0
Low Temperature Life Test	JESD22-A108	Ta=-40 °C, IF=90mA@1 serie 1000h	22	0